

# VELUX roof window GPU

## Glazing 70

**VELUX®**



The VELUX bottom-operated, top-hung roof window GPU opens outwards to connect your home to the outside and bring panoramic views and a feeling of extra space inside. The durable, moisture-resistant finish looks great in any room and is ideal for humid rooms like kitchens.

- Open the window outwards up to 45° to enjoy a panoramic view and a feeling of space.
- Open the top control bar to the ventilation position for fresh air through a closed window.
- The glazing comes standard with premium features like safety lamination, toughened glass, UV filter and our unique rain noise reduction.
- Easily rotate the window 180° for safe cleaning of the outer glass from the inside.
- Adjust the bottom handle position to ventilate your home without opening the window.
- Removable and cleanable ventilation filter protects your home from dust and insects while ventilating.
- Quickly and easily add blinds by simply clicking them into the pre-fitted brackets.



## Application guidance operation method

The window can be installed in roof pitches between 15° and 55° (75°) to the horizontal



Manual bottom-operated, top-hung roof windows open outwards for an unobstructed, panoramic view. To get the full benefit of the top-hung function, we recommend an installation height that allows for a clear sight line to the outside from both a standing and seated position. Please note that the optimum window height depends on the roof pitch.

## Available sizes and daylight area

	550	660	780	942	1140	1340
978	GPU CK04 (0.29)		GPU MK04 (0.47)			
1178	GPU CK06 (0.37)	GPU FK06 (0.47)	GPU MK06 (0.59)	GPU PK06 (0.75)	GPU SK06 (0.95)	
1398		GPU FK08 (0.58)	GPU MK08 (0.72)	GPU PK08 (0.91)	GPU SK08 (1.14)	GPU UK08 (1.41)
1600			GPU MK10 (0.85)	GPU PK10 (1.07)	GPU SK10 (1.35)	

All measurements are in mm. ( ) = Effective daylight area, m<sup>2</sup>



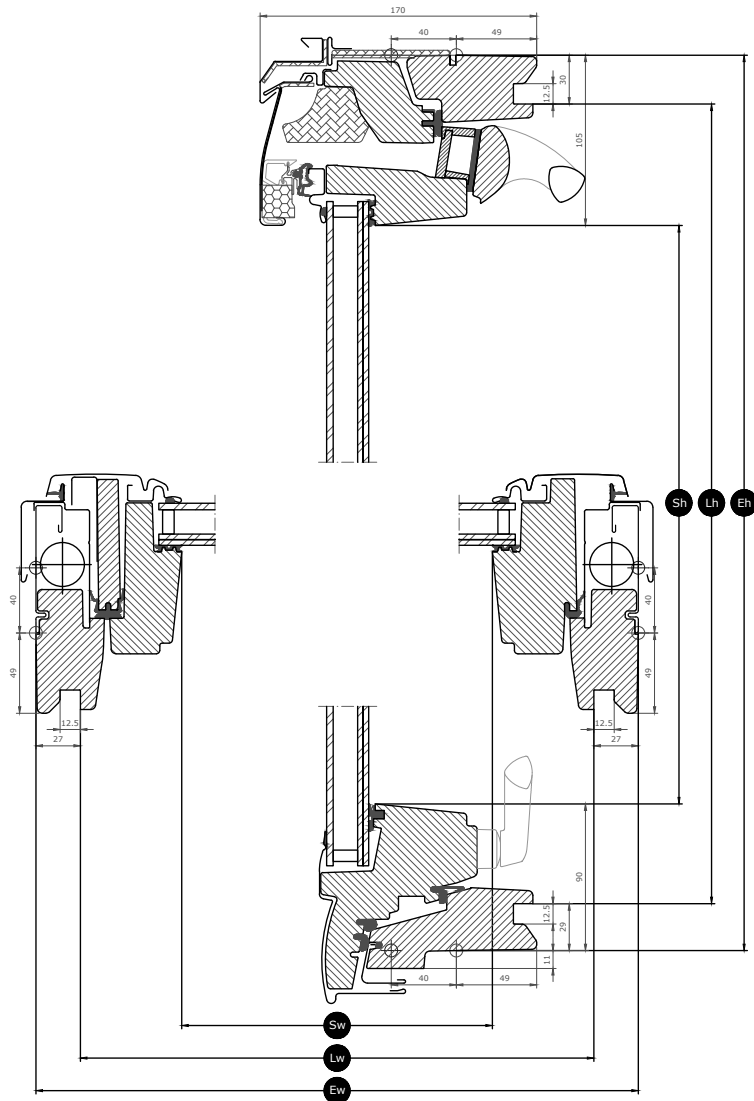





# Cross section dimensions

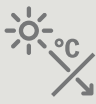

Width		CK--	FK--	MK--	PK--	SK--	UK--
Sw	Sash aperture width	371	481	601	763	961	1161
Lw	Distance between lining grooves, width	495	605	725	887	1085	1285
Ew	External frame width	550	660	780	942	1140	1340

Height		--04	--06	--08	--10
Sh	Sash aperture height	784	984	1204	1406
Lh	Distance between lining grooves, height	919	1119	1339	1541
Eh	External frame height	978	1178	1398	1600

## Glazing features

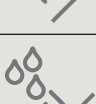
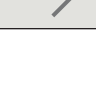
Glazing 70		
	<b>Heat insulation</b> The low energy glazing unit reduces heat loss through the window and enhanced indoor comfort.	$U_g = 1.0$
	<b>Solar gain</b> In colder climates and in rooms with large window areas, solar gain provides a better indoor climate during winter periods.	<b>0.46</b>
	<b>Solar protection</b> In warm climates and in rooms with large window areas, a sun protective glazing unit provides a better indoor climate during summer periods.	★★★★☆
	<b>Security</b> Thicker laminated inner glass increases resistance to manual attack (burglary).	★★★★☆
	<b>Safety lamination</b> Prevents glass from falling into the room in case of accidental breakage.	✓
	<b>Toughened glass</b> Adds strength to the outer glass surface to protect from wayward balls and extreme weather such as heavy storms and hail.	✓
	<b>UV filter</b> Protects your interior furnishings from fading due to the sun's harmful UV rays.	✓
	<b>Rain noise reduction</b> Rain noise reduction creates a barrier between the window and the weather outside for undisturbed moments during rainy days – or nights.	✓
	<b>Easy-to-clean</b> Dirt-repellent coating lets you spend less time cleaning and more time enjoying the view.	
	<b>Anti-dew</b> The anti-dew coating significantly reduces the days with dew on the outer glass and thus gives you a clear view.	

### Glazing structure

Glazing unit	Variant composition
Double-glazed	6.8 mm laminated float glass - 16 mm Argon - 4 mm toughened glass

## Technical values for the window

---

Overview of technical values for the product, covering among other, CE marking in accordance with EN 14351-2.

Window characteristics	Performance
Thermal transmittance	1.3 W/(m <sup>2</sup> K)
Light transmittance	0.68
Total solar energy transmittance	0.46
Sound insulation	35(-1;-3)
Air permeability	4 (PK10: 3)
External fire performance - British	AA
External fire performance - European	npd
Impact resistance	3
Load-bearing capacity of safety devices	√
Reaction to fire	D-s3,d2
Resistance to snow load	See glazing composition
Resistance to wind load	C3 (>SK08: NPD)
Water tightness	E900

NPD: No performance determined

## Visible features

---



### Operating handle, top-hung, bottom

Easy to operate handle allows for effortless opening and closing of the window.



### Lifting device, top-hung

The lifting device facilitates the opening of the top-hung sash, once engaged with the spring rods.



### Blind bracket, manual

Easily install blinds on the window without the need for extra tools. Simply click on the blind in the pre-fitted brackets.

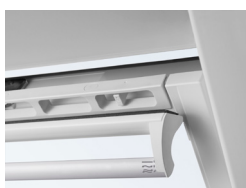

### Ventilation flap

The full-width ventilation flap can be used for ventilation even with a closed window.



### Frame hinge, centre-pivot, side

Durable hinge design allows for reliable operation and enables the sash to be rotated for easy cleaning of the outer glass.

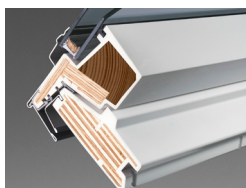

### Excellent insulation

High performance insulation materials in the window construction and thermally modified timber core increase the energy efficiency of the window.



### Barrel bolt

The barrel bolt can be placed into the integrated barrel bolt bushing to secure the window for cleaning of outer glass surface or for safe ventilation.



### Data plate

Every VELUX roof window has a unique data plate with information that can be used to look up CE marking documentation, when purchasing accessories or in case of service or replacement.

## Interior finish

---

Material Description	White maintenance-free Finished with polyurethane lacquer.
Colour code NCS, inner surface	S 0500-N
Colour code nearest RAL, inner surface	9003

## Exterior covers

---

Material Description	Aluminium, dark grey Dark grey	Titanium zinc	Untreated copper
Colour code NCS, outer surface	S 7500-N	No colour code	
Colour code nearest RAL, outer surface	7043	No colour code	

## Cleaning and maintenance

---

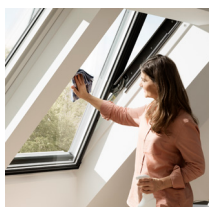

To clean the outer glass surface from the inside, rotate sash and secure in cleaning position with barrel bolts.



VELUX repair and maintenance kits are available.

## Guarantee period

---



The full terms and conditions of the VELUX Product Guarantee are available on our website [www.velux.co.uk](http://www.velux.co.uk) or [www.velux.ie](http://www.velux.ie)

## Flashings and installation products

---



### **Flashings**

Install the VELUX roof window in virtually any roofing material by using genuine VELUX flashing solutions. Our flashings are designed specifically for the exact size and shape of the roof windows to create perfect, watertight fit. Flashings can also be used to combine multiple roof windows.

### **Installation products**

Ensure a proper installation and an air- and watertight connection between the window and roof with VELUX installation products. All installation products are designed to perfectly fit the roof window for a reliable and durable result.

## Blinds, awnings and shutters

---

Complete the VELUX roof window installation with roller shutters and awning blinds for heat protection and interior blinds for light dimming, blackout and insect protection. Choose from a wide range of manually operated or remote-controlled products that are made to fit the particular window type and size. Please contact your local VELUX sales company for more details about compatibility.

## Further information

---

We reserve the right to make technical changes.

For more information on our products, please visit <https://www.velux.co.uk> or <https://www.velux.ie>.